

NBC-MS/10,0-94B/R4AC SCO - Network cable



1407417

<https://www.phoenixcontact.com/in/products/1407417>

Please be informed that the data shown in this PDF document is generated from our online catalog. Please find the complete data in the user documentation. Our general terms of use for downloads are valid.

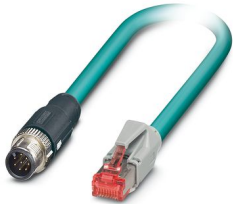

Network cable, Ethernet CAT5 (1 Gbps), 8-position, shielded, Plug straight M12 SPEEDCON, coding: A / IP67, on Plug straight RJ45 / IP20, cable length: 10 m

Commercial data

| | |
|--------------------------------------|---------------------|
| Item number | 1407417 |
| Packing unit | 1 pc |
| Minimum order quantity | 1 pc |
| Sales key | BF1 |
| Product key | BF1CMI |
| Catalog page | Page 401 (C-2-2019) |
| GTIN | 4046356775397 |
| Weight per piece (including packing) | 511 g |
| Weight per piece (excluding packing) | 481 g |
| Customs tariff number | 85444210 |
| Country of origin | PL |

1407417

<https://www.phoenixcontact.com/in/products/1407417>

Technical data

Notes

| | |
|---------|---|
| General | Further products with variable cable type and variable cable length can be found in the accessories section |
|---------|---|

Product properties

| | |
|---------------------|-------------------------|
| Product type | Data cable preassembled |
| Sensor type | Ethernet |
| Number of positions | 8 |
| Application | Standard |
| Shielded | yes |
| Coding | A |

Interfaces

| | |
|----------------------|--|
| Bus system | Ethernet |
| Signal type/category | Ethernet CAT5 (based on IEC 11801), 1 Gbps |

Signaling

| | |
|------------------------|----|
| Status display | No |
| Status display present | No |

Electrical properties

| | |
|---|-----------------------|
| Nominal voltage U_N | 30 V AC |
| | 30 V DC |
| Nominal current I_N | 1 A |
| Transmission medium | Copper |
| Transmission characteristics (category) | CAT5 (IEC 11801:2002) |

Connector

Connection 1

| | |
|-----------------------------|--|
| Type | Plug straight M12 SPEEDCON / IP67 |
| Number of positions | 8 |
| Locking type | SPEEDCON |
| Coding type | A (Standard) |
| Handle color | black |
| Material | CuZn (Contact) |
| | Ni/Au (Contact surface) |
| | TPU GF (Contact carriers) |
| | TPU, hardly inflammable, self-extinguishing (Grip) |
| | Zinc die-cast, nickel-plated (Screw connection) |
| Insertion/withdrawal cycles | ≥ 100 |
| Contact resistance | $\leq 5 \text{ m}\Omega$ |
| Insulation resistance | $\geq 100 \text{ M}\Omega$ |

NBC-MS/10,0-94B/R4AC SCO - Network cable



1407417

<https://www.phoenixcontact.com/in/products/1407417>

| | |
|---------------------------------|------------------|
| Tightening torque | 0.4 Nm |
| Degree of protection | IP67 |
| Ambient temperature (operation) | -25 °C ... 90 °C |

Connection 2

| | |
|---------------------------------|---------------------------|
| Type | Plug straight RJ45 / IP20 |
| Number of positions | 8 (8) |
| Handle color | gray |
| Material | CuSn (Contact) |
| | Ni/Au (Contact surface) |
| | PC (Contact carriers) |
| | PA (Housing) |
| Insertion/withdrawal cycles | ≥ 750 |
| Degree of protection | IP20 |
| Ambient temperature (operation) | -25 °C ... 60 °C |

Cable/line

| | |
|--------------|------|
| Cable length | 10 m |
|--------------|------|

Ethernet flexible CAT5, 4-pair [94B]

| | |
|---------------------------------|--|
| Dimensional drawing |  |
| Cable weight | 47 kg/km |
| UL AWM Style | 20963 (80°C/30 V) |
| Number of positions | 8 |
| Shielded | yes |
| Cable type | Ethernet flexible CAT5, 4-pair [94B] |
| Conductor structure | 4x2xAWG26/7, SF/UTP |
| Signal runtime | 5.3 ns/m |
| Conductor structure signal line | 7x 0.16 mm |
| AWG signal line | 26 |
| Conductor cross section | 4x 2x 0.14 mm ² |
| Wire diameter incl. insulation | 0.96 mm |
| External cable diameter | 6.4 mm ±0.2 mm |
| Outer sheath, material | PUR |
| External sheath, color | water blue RAL 5021 |
| Conductor material | Bare Cu litz wires |
| Material wire insulation | Foamed PE |
| Single wire, color | white/blue-blue, white/orange-orange, white/green-green, |

NBC-MS/10,0-94B/R4AC SCO - Network cable



1407417

<https://www.phoenixcontact.com/in/products/1407417>

| | |
|--|--|
| | white/brown-brown |
| Thickness, outer sheath | 1.05 mm |
| Twisted pairs | 2 cores to the pair |
| Overall twist | 4 pairs for core |
| Optical shield covering | 70 % |
| Insulation resistance | $\geq 5 \text{ G}\Omega \cdot \text{km}$ |
| Coupling resistance | $\leq 100.00 \text{ m}\Omega/\text{m}$ (at 10 MHz) |
| Loop resistance | $\leq 290.00 \text{ }\Omega/\text{km}$ |
| Wave impedance | $100 \text{ }\Omega \pm 5 \text{ }\Omega$ (at 100 MHz) |
| Cable capacity | 48 nF/km (at 1 kHz) |
| Nominal voltage, cable | $\leq 100 \text{ V}$ |
| Test voltage Core/Core | 700 V (50 Hz, 1 min.) |
| Test voltage Core/Shield | 700 V (50 Hz, 1 min.) |
| Minimum bending radius, fixed installation | 4 x D |
| Minimum bending radius, flexible installation | 8 x D |
| Smallest bending radius, fixed installation | 26 mm |
| Smallest bending radius, movable installation | 52 mm |
| Tensile strength | $\leq 100 \text{ N}$ |
| Near end crosstalk attenuation (NEXT) | 71.3 dB (with 1 MHz) |
| | 62.3 dB (at 4 MHz) |
| | 56.3 dB (at 10 MHz) |
| | 53.2 dB (at 16 MHz) |
| | 51.8 dB (at 20 MHz) |
| | 48.9 dB (at 31.25 MHz) |
| | 44.4 dB (at 62.5 MHz) |
| Power-summated near end crosstalk attenuation (PSNEXT) | 41.3 dB (at 100 MHz) |
| | 62.3 dB (with 1 MHz) |
| | 53.3 dB (at 4 MHz) |
| | 47.3 dB (at 10 MHz) |
| | 44.2 dB (at 16 MHz) |
| | 42.8 dB (at 20 MHz) |
| | 39.9 dB (at 31.25 MHz) |
| 35.4 dB (at 62.5 MHz) | |
| Return attenuation (RL) | 32.3 dB (at 100 MHz) |
| | 23 dB (at 4 MHz) |
| | 24.1 dB (at 8 MHz) |
| | 25 dB (at 10 MHz) |
| | 25 dB (at 16 MHz) |
| | 25 dB (at 20 MHz) |
| | 23.6 dB (at 31.25 MHz) |
| 21.5 dB (at 62.5 MHz) | |
| Shield attenuation | 20.1 dB (at 100 MHz) |
| | 3.2 dB (with 1 MHz) |
| | 6 dB (at 4 MHz) |

NBC-MS/10,0-94B/R4AC SCO - Network cable



1407417

<https://www.phoenixcontact.com/in/products/1407417>

| | |
|------------------------------------|---|
| | 9.5 dB (at 10 MHz) |
| | 12.1 dB (at 16 MHz) |
| | 13.6 dB (at 20 MHz) |
| | 17.1 dB (at 31.25 MHz) |
| | 24.8 dB (at 62.5 MHz) |
| | 32 dB (at 100 MHz) |
| Halogen-free | according to IEC 60754-1 |
| Flame resistance | according to IEC 60332-1-2 |
| Resistance to oil | in accordance with EN 60811-2-1 |
| Ambient temperature (operation) | -40 °C ... 80 °C (cable, fixed installation) -20 °C ... 80 °C (Cable, flexible installation) |
| Ambient temperature (installation) | -20 °C ... 80 °C |

Environmental and real-life conditions

Ambient conditions

| | |
|---------------------------------|---|
| Degree of protection | IP65 (M12 connector) IP67 (M12 connector) IP20 (RJ45 connector) |
| Ambient temperature (operation) | -25 °C ... 90 °C (M12 connector) -20 °C ... 70 °C (RJ45 connector) |

Standards and regulations

M12

| | |
|--------------------------|-----------------|
| Standard designation | M12 connector |
| Standards/specifications | IEC 61076-2-101 |

Drawings

Circuit diagram

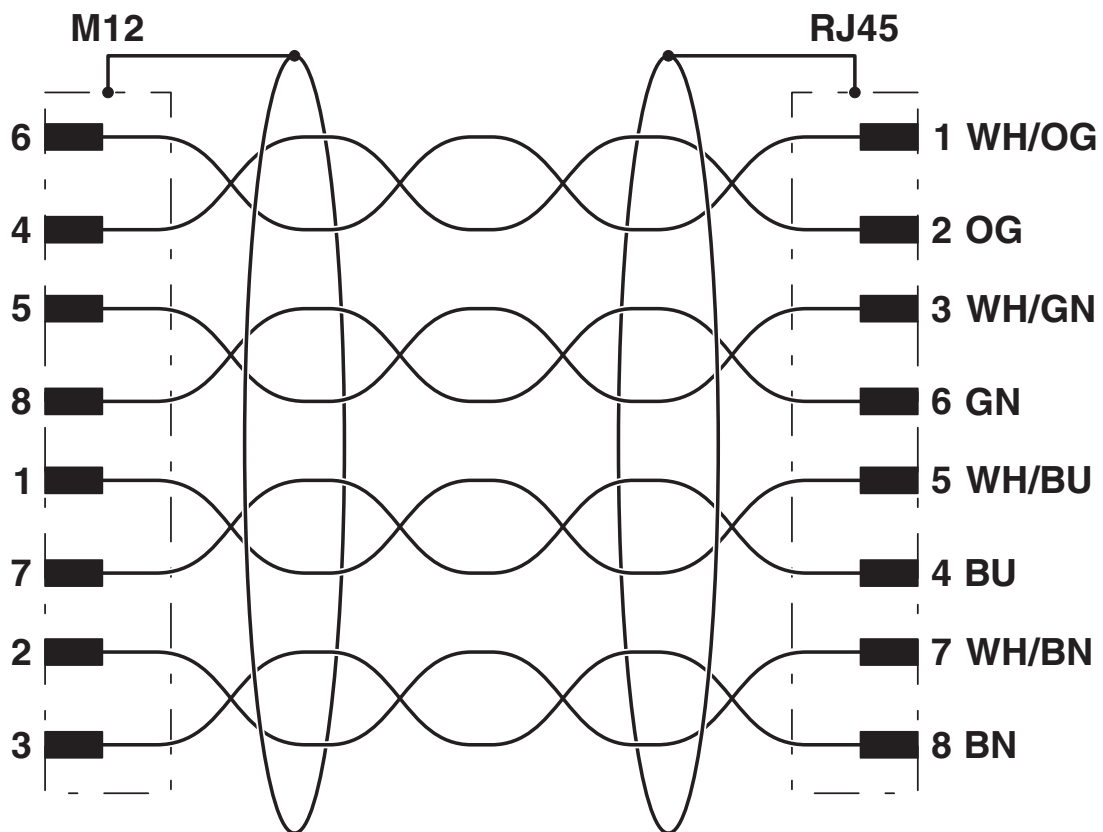

1407417

<https://www.phoenixcontact.com/in/products/1407417>

Schematic diagram



Connector pin assignment plug RJ45

NBC-MS/10,0-94B/R4AC SCO - Network cable

1407417

<https://www.phoenixcontact.com/in/products/1407417>

Dimensional drawing

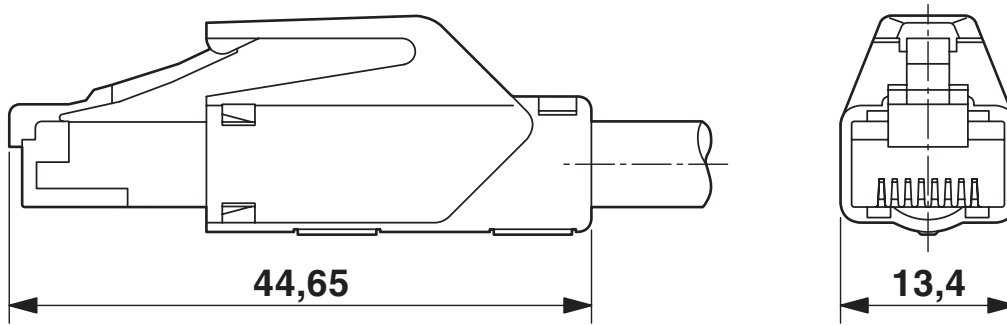

RJ45 connector, IP20

Dimensional drawing

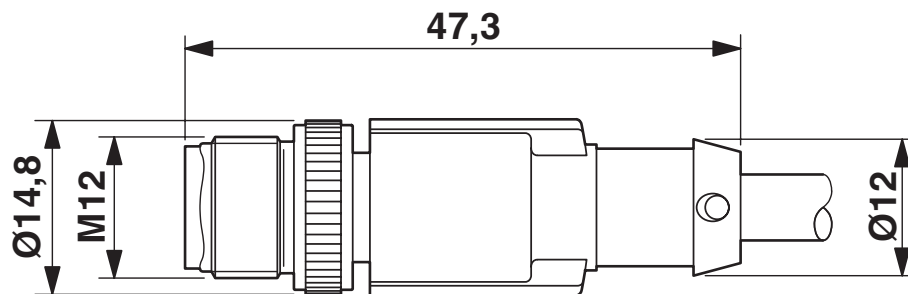

Plug, M12 x 1, straight, shielded

1407417

<https://www.phoenixcontact.com/in/products/1407417>

Schematic diagram

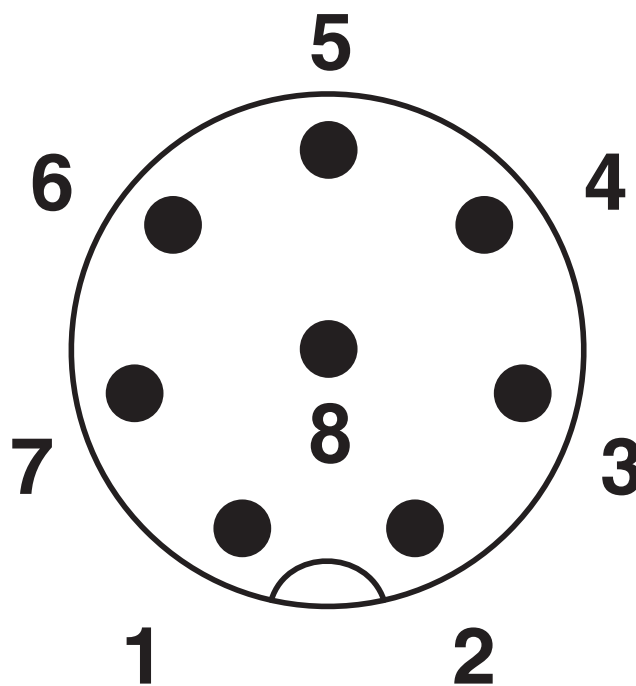

Pin assignment M12 plug, 8-pos., A-coded, view plug side

1407417

<https://www.phoenixcontact.com/in/products/1407417>

Approvals

To download certificates, visit the product detail page: <https://www.phoenixcontact.com/in/products/1407417>

|  UL Listed Approval ID: FILE E 335024 | | | | |
|--|-----------------------|-----------------------|-------------------|----------------------|
| | Nominal voltage U_N | Nominal current I_N | Cross section AWG | Cross section mm^2 |
| | 30 V | 0.5 A | - | - |

|  cUL Listed Approval ID: FILE E 335024 | | | | |
|---|-----------------------|-----------------------|-------------------|----------------------|
| | Nominal voltage U_N | Nominal current I_N | Cross section AWG | Cross section mm^2 |
| | 30 V | 0.5 A | - | - |

|  EAC-RoHS Approval ID: RU D-DE.HB35.B.00387 | |
|---|--|
|---|--|

| cULus Listed | |
|---------------------|--|
|---------------------|--|

NBC-MS/10,0-94B/R4AC SCO - Network cable



1407417

<https://www.phoenixcontact.com/in/products/1407417>

Classifications

ECLASS

| | |
|-------------|----------|
| ECLASS-11.0 | 27060307 |
| ECLASS-12.0 | 27060307 |
| ECLASS-13.0 | 27060307 |

ETIM

| | |
|----------|----------|
| ETIM 9.0 | EC001855 |
|----------|----------|

UNSPSC

| | |
|-------------|----------|
| UNSPSC 21.0 | 26121600 |
|-------------|----------|

NBC-MS/10,0-94B/R4AC SCO - Network cable



1407417

<https://www.phoenixcontact.com/in/products/1407417>

Environmental product compliance

| | |
|------------|---|
| China RoHS | Environmentally friendly use period: unlimited = EFUP-e |
| | No hazardous substances above threshold values |

NBC-MS/10,0-94B/R4AC SCO - Network cable



1407417

<https://www.phoenixcontact.com/in/products/1407417>

Accessories

NBC-MS-R4AC SCO-IE/.../... - Network cable

1408681

<https://www.phoenixcontact.com/in/products/1408681>



Network cable, Ethernet CAT5 (1 Gbps), 8-position, Variable cable type, shielded, Plug straight M12 SPEEDCON, coding: A / IP67, on Plug straight RJ45 / IP20, cable length: Free input (0.2 ... 40.0 m)

NBC-MR-R4AC SCO-IE/.../... - Network cable

1408674

<https://www.phoenixcontact.com/in/products/1408674>



Network cable, Ethernet CAT5 (1 Gbps), 8-position, Variable cable type, shielded, Plug angled M12 SPEEDCON, coding: A / IP67, on Plug straight RJ45 / IP20, cable length: Free input (0.2 ... 40.0 m)

NBC-MS/10,0-94B/R4AC SCO - Network cable

1407417

<https://www.phoenixcontact.com/in/products/1407417>



NBC-FS-R4AC SCO-IE/.../... - Network cable

1408664

<https://www.phoenixcontact.com/in/products/1408664>



Network cable, Ethernet CAT5 (1 Gbps), 8-position, Variable cable type, shielded, Socket straight M12 SPEEDCON, coding: A / IP67, on Plug straight RJ45 / IP20, cable length: Free input (0.2 ... 40.0 m)

NBC-FR-R4AC SCO-IE/.../... - Network cable

1408655

<https://www.phoenixcontact.com/in/products/1408655>



Network cable, Ethernet CAT5 (1 Gbps), 8-position, Variable cable type, shielded, Socket angled M12 SPEEDCON, coding: A / IP67, on Plug straight RJ45 / IP20, cable length: Free input (0.2 ... 40.0 m)

NBC-MS/10,0-94B/R4AC SCO - Network cable



1407417

<https://www.phoenixcontact.com/in/products/1407417>

PROT-M12 FS-PA-CHAIN - Sealing cap

1430873

<https://www.phoenixcontact.com/in/products/1430873>

M12 sealing cap made of plastic with fixing band, for sensor cables, for free M12 plugs



SAC-M12-EXCLIP-M - Locking clip

1558988

<https://www.phoenixcontact.com/in/products/1558988>

Locking clip for the pin side of sensor/actuator cables with M12 connector and M12 connectors for assembly, for knurl diameter: 15 mm or for Allen key with a wrench size of 14 mm, prevents the disconnection of plug-in connections without tools



NBC-MS/10,0-94B/R4AC SCO - Network cable



1407417

<https://www.phoenixcontact.com/in/products/1407417>

TSD 04 SAC - Torque screwdriver

1208429

<https://www.phoenixcontact.com/in/products/1208429>



Torque screwdriver, with preset torque of 0.4 Nm and 4 mm hexagonal drive for M12 connectors

TSD-M 1,2NM - Torque screwdriver

1212224

<https://www.phoenixcontact.com/in/products/1212224>



Torque screw driver, accuracy as per EN ISO 6789 standard, adjustable from 0.3 - 1.2 Nm

NBC-MS/10,0-94B/R4AC SCO - Network cable



1407417

<https://www.phoenixcontact.com/in/products/1407417>

TSD-M SAC-BIT ADAPTER - Adapter insert

1212600

<https://www.phoenixcontact.com/in/products/1212600>



Adapter bit for TSD-M...torque tools, E6.3-1/4" drive with 4 mm hexagon to accommodate SAC bits

SAC BIT M12-D15 - Tool

1208432

<https://www.phoenixcontact.com/in/products/1208432>



Nut for assembling sensor/actuator cables with M12 connector and M12 connectors for assembly, with a knurl diameter of 15 mm, for 4 mm hexagonal drive

Phoenix Contact 2024 © - all rights reserved
<https://www.phoenixcontact.com>

PHOENIX CONTACT (I) Pvt. Ltd.
A-58/2, Okhla Industrial Area, Phase - II, New Delhi-110 020

+91.1275.71420
info@phoenixcontact.co.in